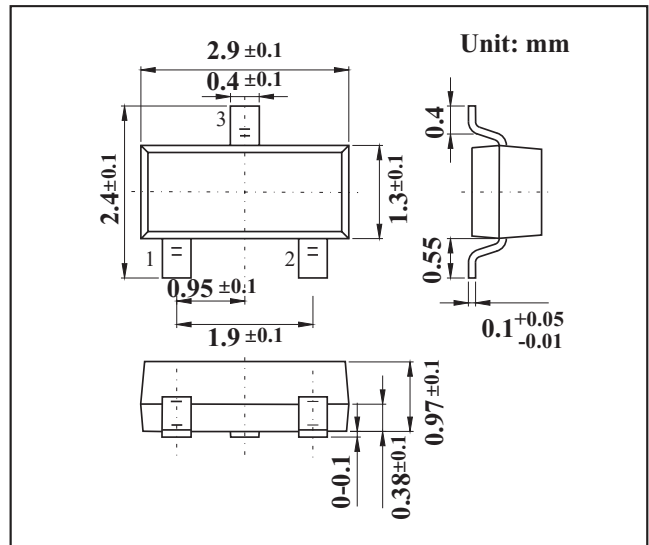

SOT-23 Plastic-Encapsulate MOSFETS
FEATURES

- VDS (V) = 30V
- ID = 4 A
- RDS(ON) < 5.5mΩ (VGS = 10V)
- RDS(ON) < 7.0mΩ (VGS = 4.5V)
- RDS(ON) < 1.10mΩ (VGS = 2.5V)
- N-Channel Enhancement Mode Field Effect Transistor

MECHANICAL DATA

- Case style: SOT-23 molded plastic
- Mounting position: any

MAXIMUM RATINGS AND CHARACTERISTICS

@ 25°C Ambient Temperature (unless otherwise noted)

Parameter	Symbol	Rating	Unit
Drain-Source Voltage	V _{DS}	30	V
Gate-Source Voltage	V _{GS}	±12	V
Continuous Drain Current TA=25°C TA=70°C	I _D	4 3.4	A
Pulsed Drain Current	I _{DM}	15	
Power Dissipation TA=25°C TA=70°C	P _D	1.4 1	W
Thermal Resistance.Junction-to-Ambient	R _{θJA}	125	°C/W
Thermal Resistance.Junction-to-Case	R _{θJC}	80	°C/W
Junction and Storage Temperature Range	T _J , T _{STG}	-55 to 150	°C



MOSFET ELECTRICAL CHARACTERISTICS Ta=25 °C unless otherwise specified

Parameter	Symbol	Test Condition	Min	Typ	Max	Unit
Drain-Source Breakdown Voltage	V _{DSS}	I _D =250 μ A, V _{GS} =0V	30			V
Zero Gate Voltage Drain Current	I _{DSS}	V _{DS} =24V, V _{GS} =0V			1	μ A
		V _{DS} =24V, V _{GS} =0V, T _J =55°C			5	
Gate-Body leakage current	I _{GSS}	V _{DS} =0V, V _{GS} =± 12V			± 100	nA
Gate Threshold Voltage	V _{GS(th)}	V _{DS} =V _{GS} I _D =250 μ A	0.6	1	1.4	V
Static Drain-Source On-Resistance	R _{DS(ON)}	V _{GS} =10V, I _D =4A		45	55	m Ω
		V _{GS} =10V, I _D =4A T _J =125°C		66	80	
		V _{GS} =4.5V, I _D =3A		55	70	m Ω
		V _{GS} =2.5V, I _D =2A		83	110	m Ω
On state drain current	I _{D(ON)}	V _{GS} =4.5V, V _{DS} =5V	10			A
Forward Transconductance	g _{FS}	V _{DS} =5V, I _D =4A		8		S
Input Capacitance	C _{iss}	V _{GS} =0V, V _{DS} =15V, f=1MHz		390		pF
Output Capacitance	C _{oss}			54.5		pF
Reverse Transfer Capacitance	C _{rss}			41		pF
Gate resistance	R _g	V _{GS} =0V, V _{DS} =0V, f=1MHz		3		Ω
Total Gate Charge	Q _g	V _{GS} =4.5V, V _{DS} =15V, I _D =-4A		4.34		nC
Gate Source Charge	Q _{gs}			0.6		nC
Gate Drain Charge	Q _{gd}			1.38		nC
Turn-On DelayTime	t _{D(on)}	V _{GS} =10V, V _{DS} =15V, R _L =3.75 Ω, R _{GEN} =6 Ω		3.3		ns
Turn-On Rise Time	t _r			1		ns
Turn-Off DelayTime	t _{D(off)}			21.7		ns
Turn-Off Fall Time	t _f			2.1		ns
Body Diode Reverse Recovery Time	t _{rr}	I _F =4A, di/dt=100A/ μ s		12		ns
Body Diode Reverse Recovery Charge	Q _{rr}	I _F =4A, di/dt=100A/ μ s		6.3		nC
Maximum Body-Diode Continuous Current	I _S				2.5	A
Diode Forward Voltage	V _{SD}	I _S =1A, V _{GS} =0V		0.8	1	V

RATINGS AND CHARACTERISTIC CURVES

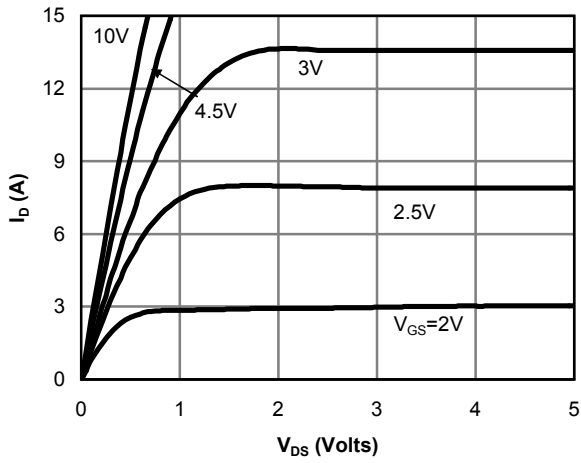

Fig 1: On-Region Characteristics

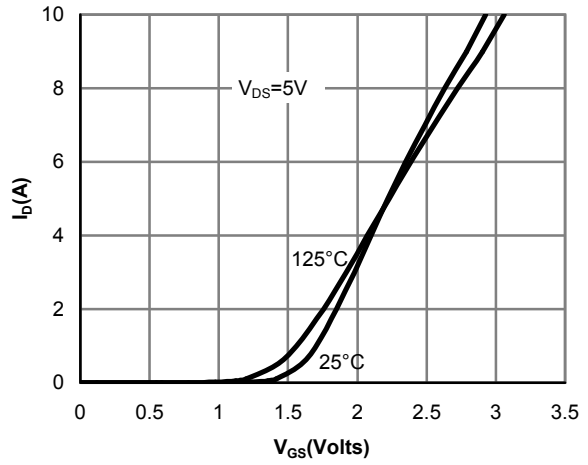

Figure 2: Transfer Characteristics

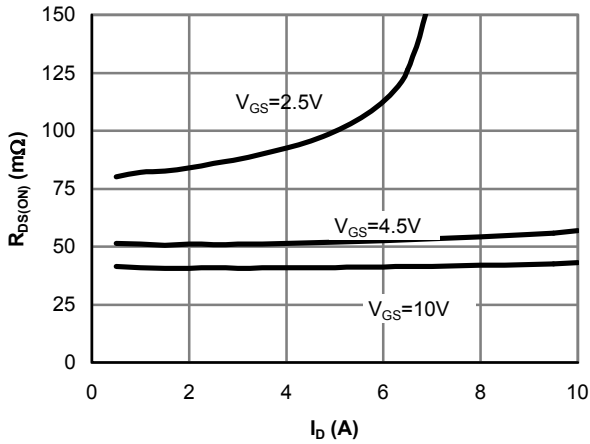

Figure 3: On-Resistance vs. Drain Current and Gate Voltage

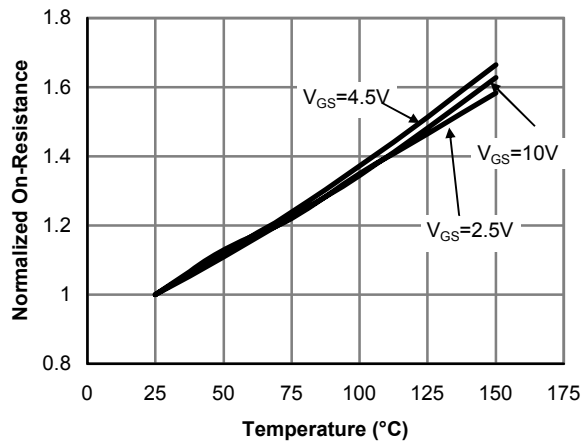

Figure 4: On-Resistance vs. Junction Temperature

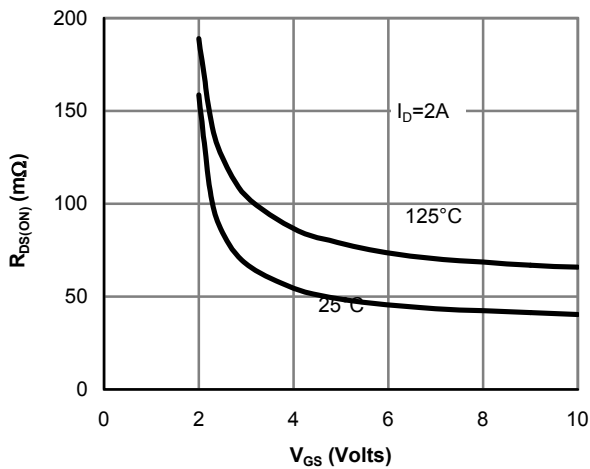

Figure 5: On-Resistance vs. Gate-Source Voltage

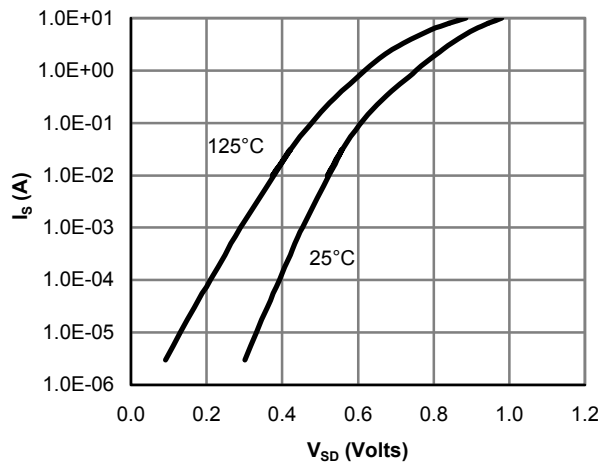

Figure 6: Body-Diode Characteristics

RATINGS AND CHARACTERISTIC CURVES

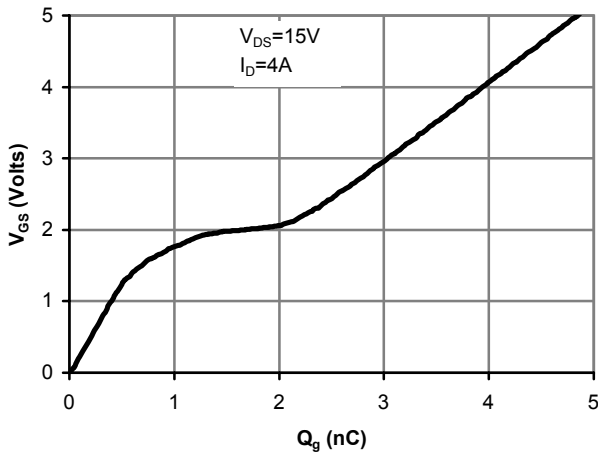

Figure 7: Gate-Charge Characteristics

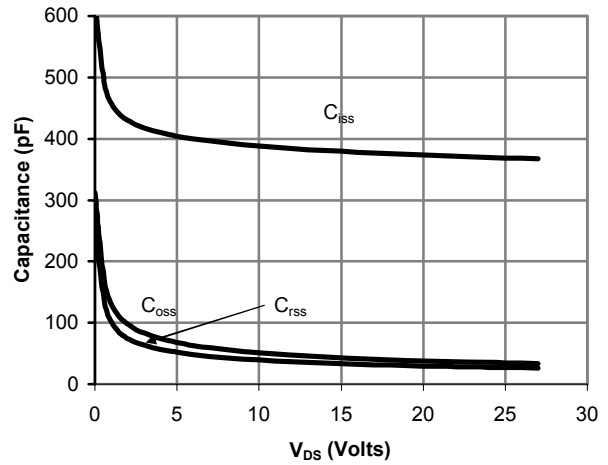

Figure 8: Capacitance Characteristics

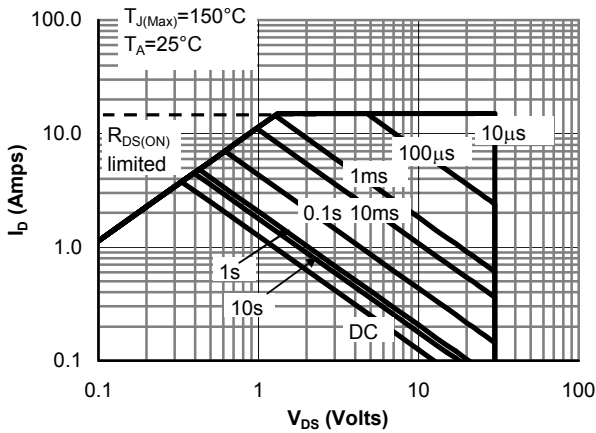

Figure 9: Maximum Forward Biased Safe Operating Area (Note E)

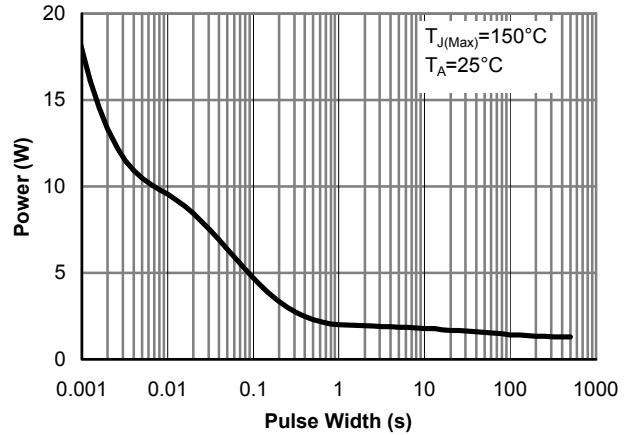

Figure 10: Single Pulse Power Rating Junction-to-Ambient (Note E)

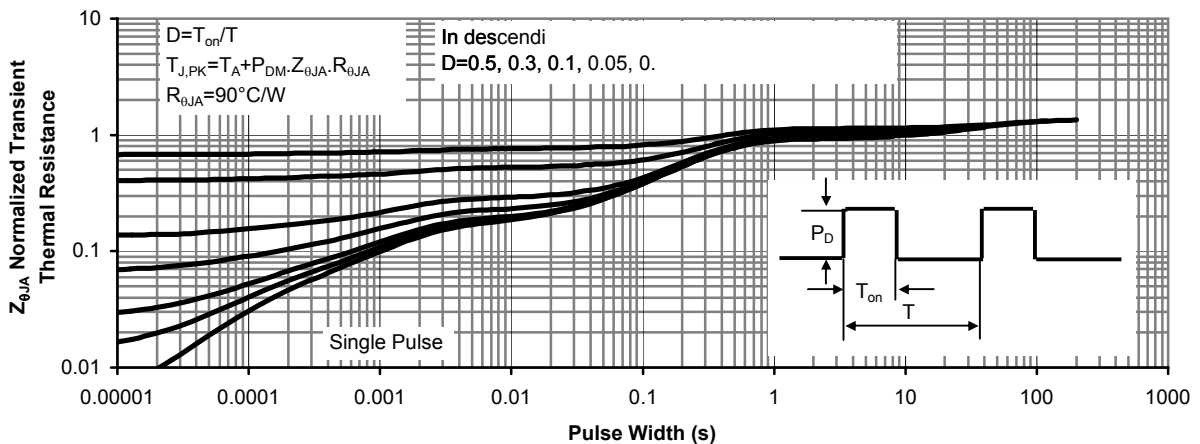

Figure 11: Normalized Maximum Transient Thermal Impedance